

TEHNIČNI LIST – DIMENZIJE HIDROMOTORJI MM SIDE

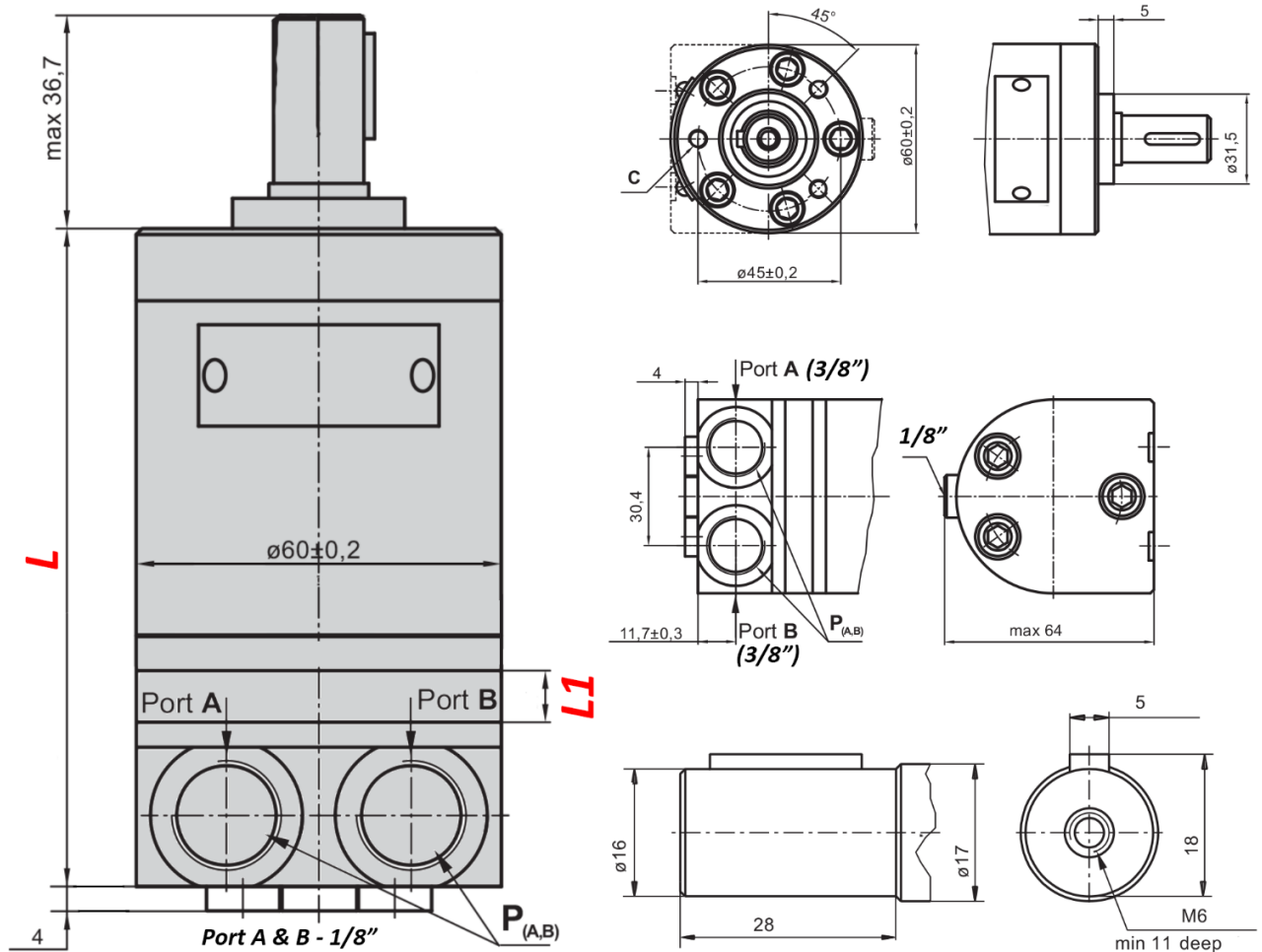

	L	L1
	(mm)	
MM SIDE 8	106,4	3,5
MM SIDE 12,5	108,4	5,5
MM SIDE 20	111,4	8,5
MM SIDE 32	116,4	13,5
MM SIDE 40	119,9	17
MM SIDE 50	123,9	21

		MM SIDE 8	MM SIDE 12,5	MM SIDE 20	MM SIDE 32	MM SIDE 40	MM SIDE 50
cm/vrtljaji		8,2	12,5	19,9	31,6	39,8	50
Vrtljaji [rpm]	konstantni	1950	1550	1000	630	500	400
	s prekinitvami	2450	1940	1250	800	630	500
Navor [daNm]	konstantni	1,1	1,6	2,5	4	4,5	4,6
	s prekinitvami	1,5	2,3	3,5	5,7	7	8,8
	max.	2,1	3,3	5,1	6,4	8,2	10
Moč [kW]	konstantna	1,8	2,4	2,4	2,4	2,2	1,8
	s prekinitvami	2,6	3,2	3,2	3,2	3,2	3,2
Priključni tlak [bar]	konstantni	140	140	140	140	140	140
	s prekinitvami	175	175	175	175	175	175
	max.	225	225	225	225	225	225
Padeč tlaka [bar]	konstantni	100	100	100	100	90	70
	s prekinitvami	140	140	140	140	140	140
	max.	200	200	200	160	160	160
Pretok olja [L/min]	konstantni	16	20	20	20	20	20
	s prekinitvami	20	25	25	25	25	25
Priključni navoj		3/8"	3/8"	3/8"	3/8"	3/8"	3/8"
Teža [kg]		1,9	2	2,1	2,2	2,3	2,5

DIAGRAMI

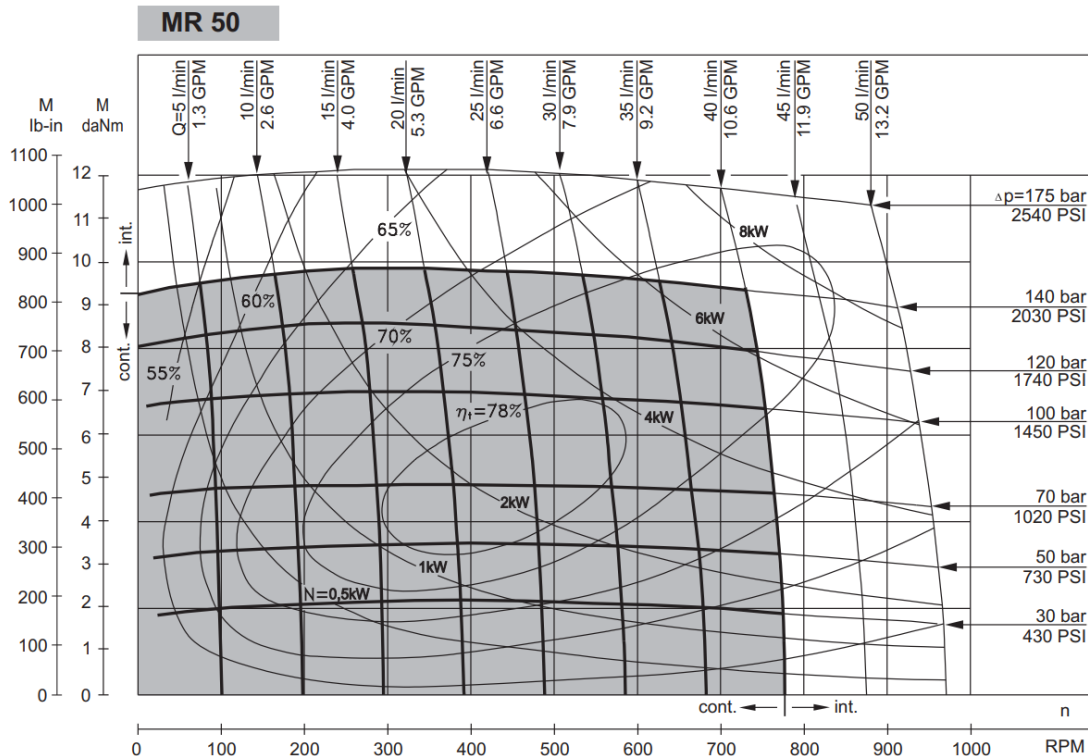

MR 80

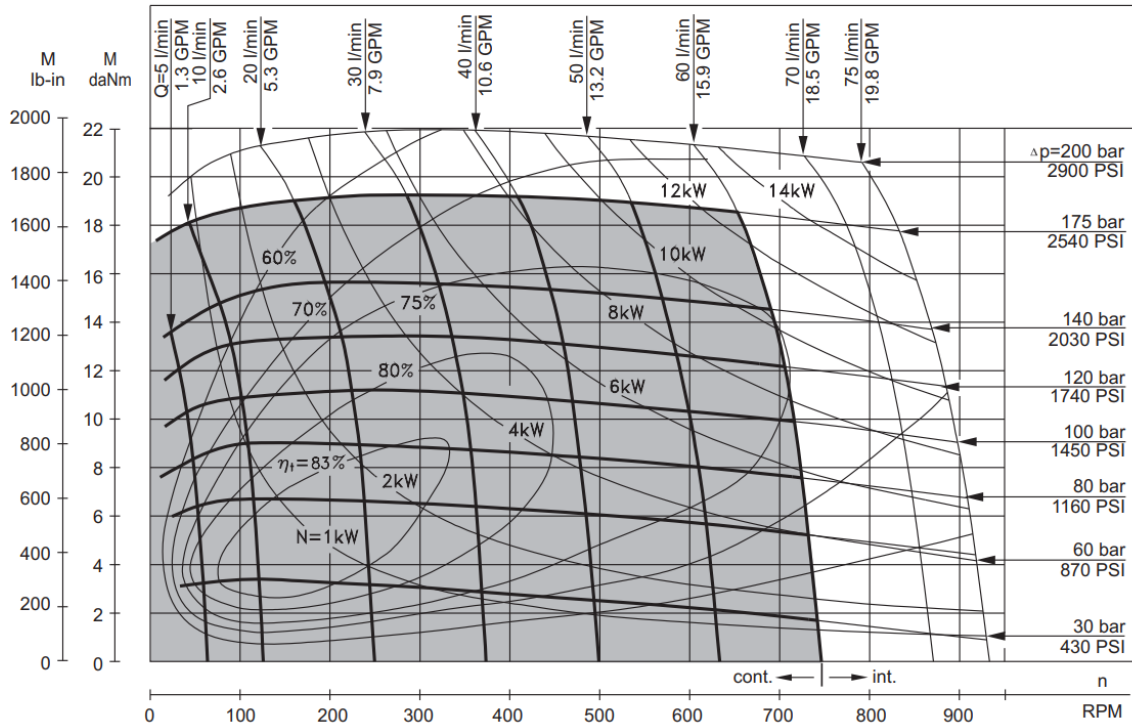

MR 100

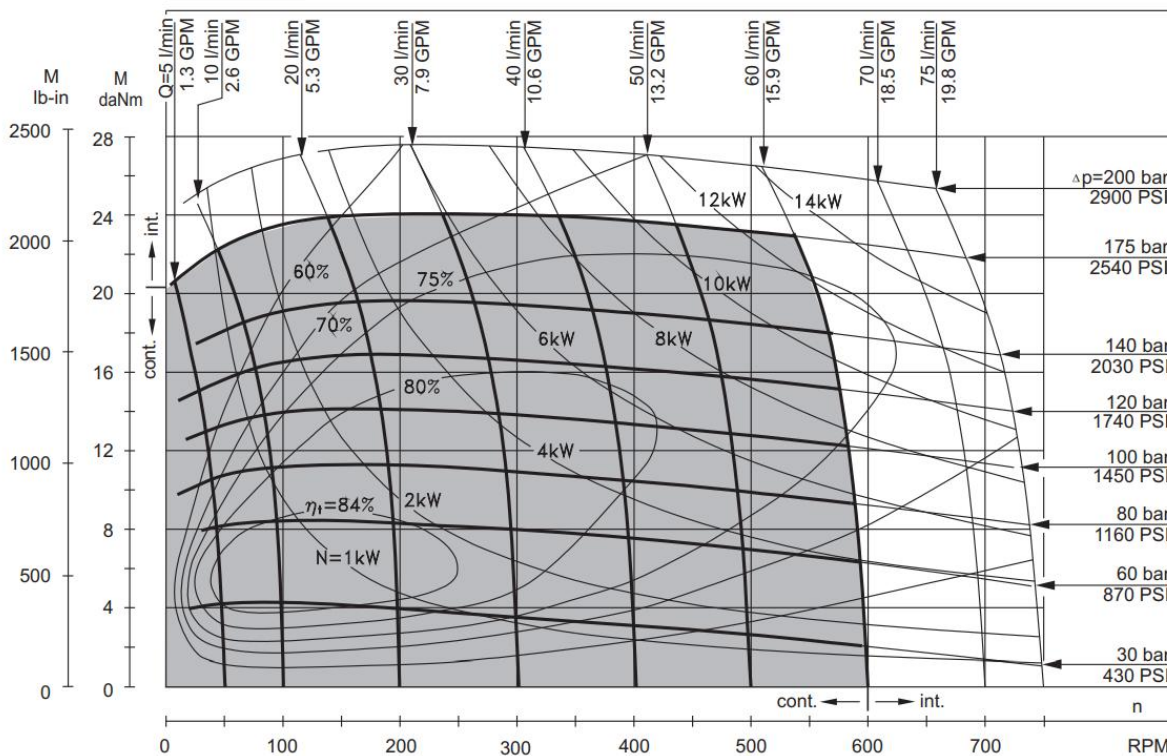

MR 125

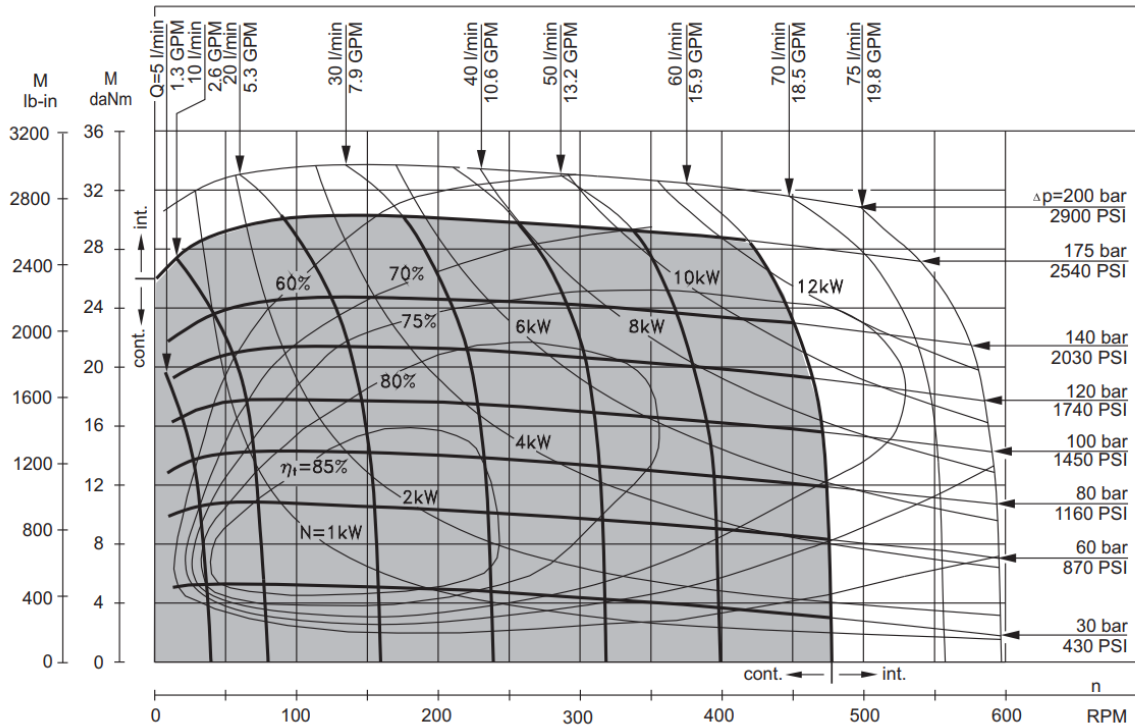

MR 160

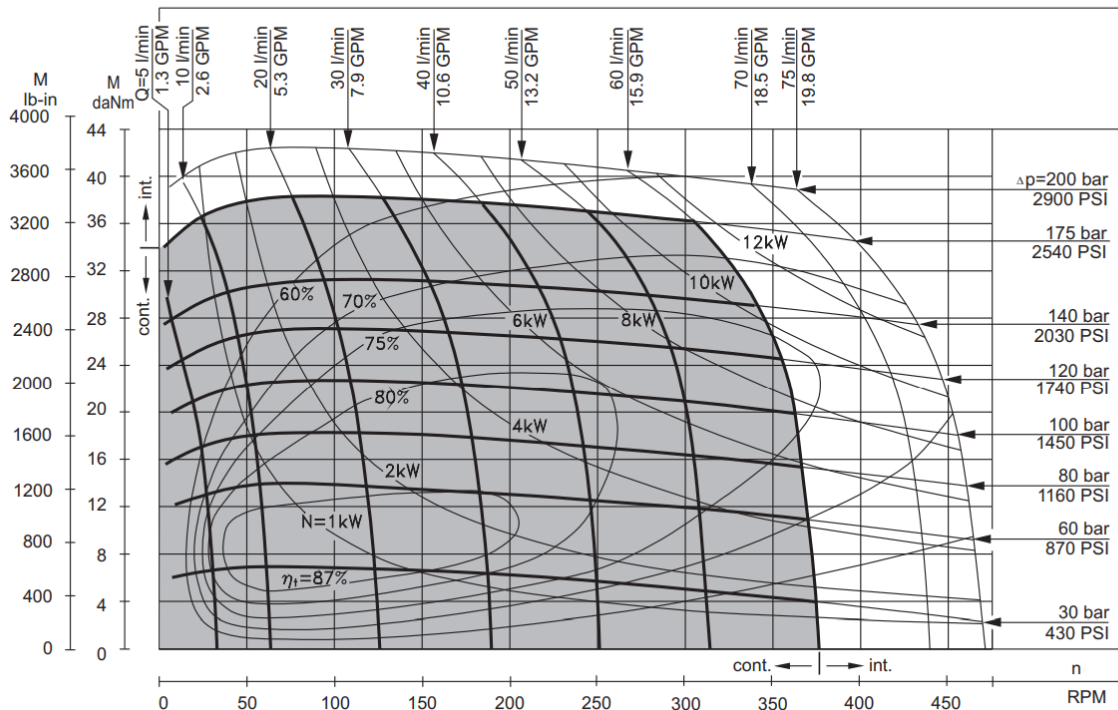

MR 200

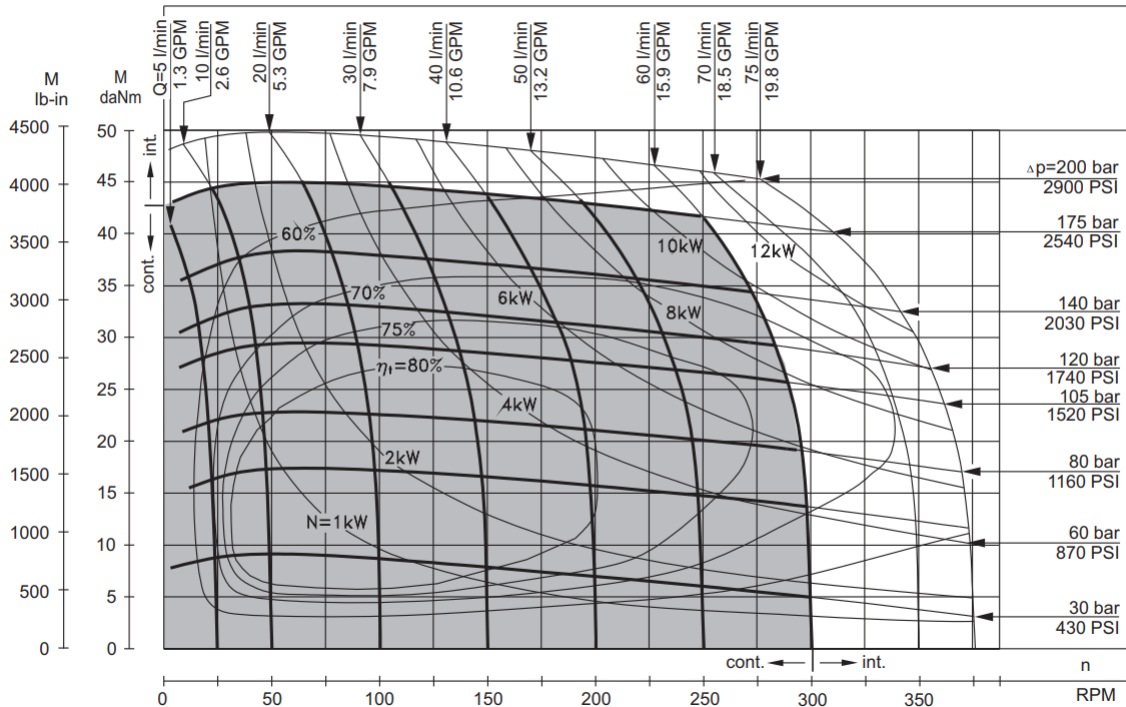

MR 250

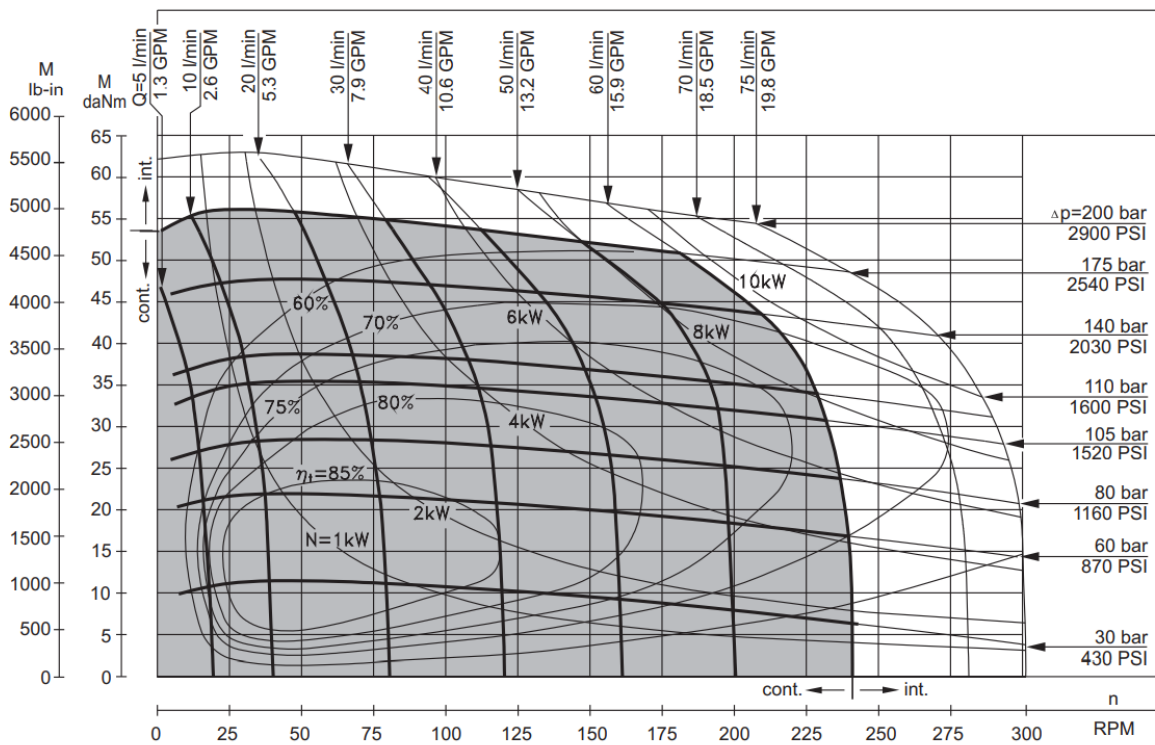

MR 315

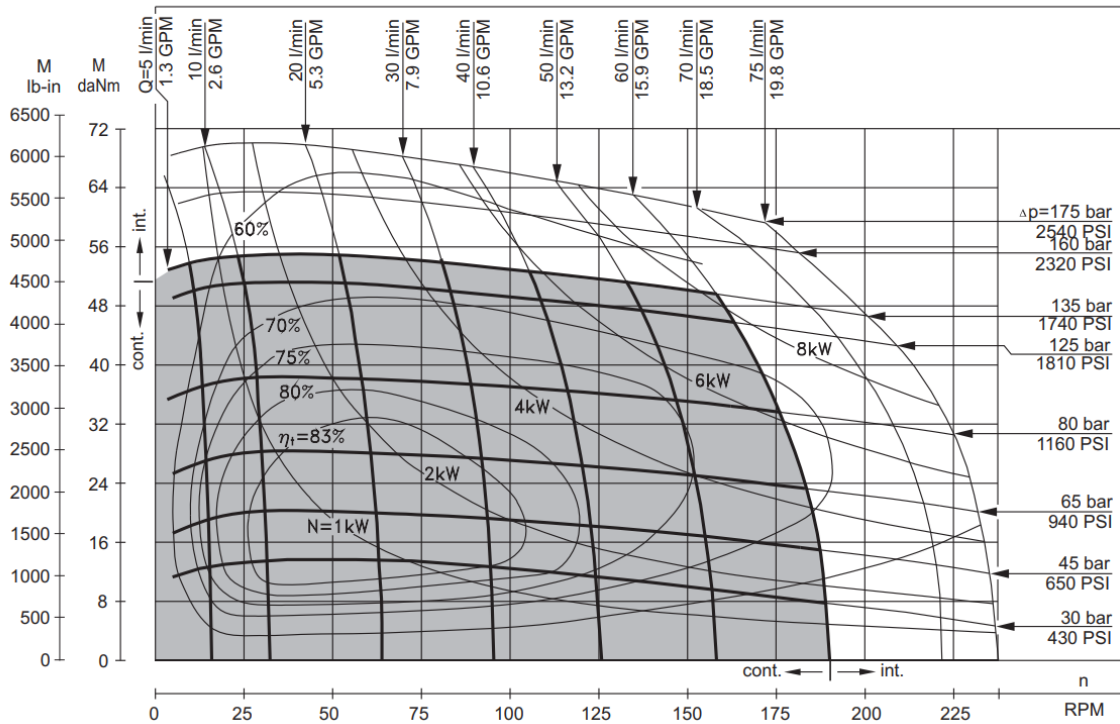

MR 400

