

TEHNIČNI LIST - DIMENZIJE HIDRAVLIČNI CILINDRI STANDARD 60/30-xxx

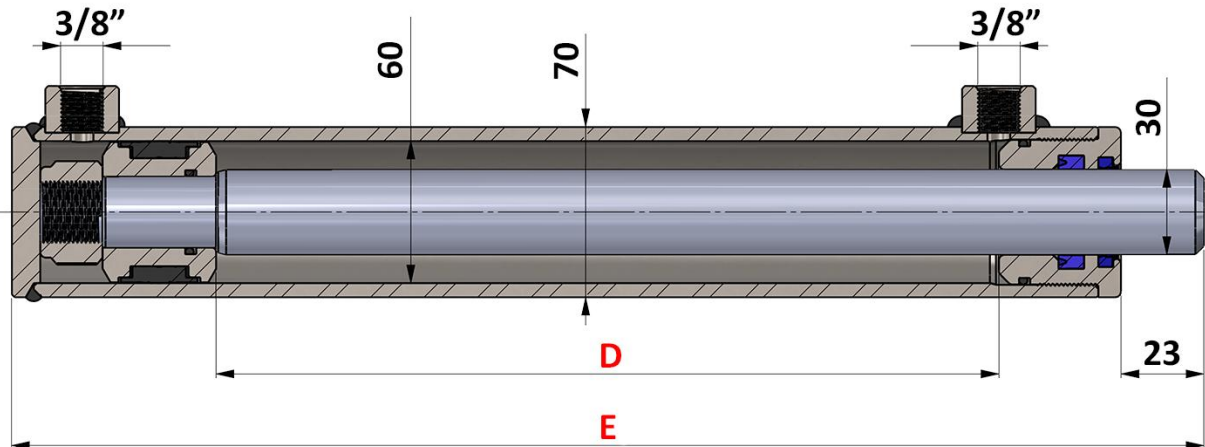

	STANDARD	E	D (hod)
Šifra	60/30-xxx	[mm]	
10769	60/30-100	260	100
10674	60/30-150	310	150
10770	60/30-200	360	200
10771	60/30-250	410	250
10772	60/30-300	460	300
10773	60/30-350	510	350
10774	60/30-400	560	400
10775	60/30-450	610	450
10776	60/30-500	660	500
14145	60/30-550	710	550
10777	60/30-600	760	600
10778	60/30-700	860	700
10779	60/30-800	960	800
10780	60/30-900	1060	900
10781	60/30-1000	1160	1000
12250	60/30-1100	1260	1100
12251	60/30-1200	1360	1200
12252	60/30-1300	1460	1300
12253	60/30-1400	1560	1400
12254	60/30-1500	1660	1500
14835	60/30-1750	1910	1750
14836	60/30-2000	2160	2000